



315-545-2027

[dh@twinclover.net](mailto:dh@twinclover.net)

[twincloverequipment.com](http://twincloverequipment.com)

# Product Catalogue

---

USA EDITION

2026

[twincloverequipment.com](http://twincloverequipment.com)



**iLivestock is here to make data-capture accessible for livestock ranchers all over the world.**

We create software and hardware solutions specifically designed to make it easy, simple and affordable for cattle and sheep ranchers to capture data on the ranch. With affordable farm technology - that fits any livestock ranch, is right for them and can grow with their business without fuss - we empower ranchers to make better informed business decisions. Ultimately, to increase their profitability, productivity, and reduce the ranch's carbon footprint.



## Contents

---

<b>About iLivestock</b>	4
<b>Software</b>	
■ iLivestock Software	6
■ eWeigh Software	7
<b>Reading</b>	
■ eTagReader	8
<b>Weighing</b>	
■ eWeigh	10
■ eWeighDS	12
■ eWeighBar 600	14
■ eWeighBar 800	16
■ eWeighBar HD	18
■ eWeighCell	20

## About us

iLivestock makes data-capture easy and affordable for livestock ranchers. We offer software and hardware solutions tailored for cattle and sheep ranching, designed to help ranchers move their business forward, increase their profitability, productivity, and reduce their ranch's carbon footprint.

## Industrial recognition

iLivestock is proud to be recognised for its innovative livestock management solutions, picking up awards that showcase progress in agricultural technology.

The iLivestock Platform has received praise for the positive impact it's having on modern ranching, with recognition for delivering practical, effective solutions that help ranchers monitor and improve livestock performance more easily and efficiently. By reducing costs, it provides sheep and cattle ranchers with a simple, affordable way to collect valuable animal data.

We are grateful to our exclusive strategic partners in the UK and around the world, whose support and collaboration have been key to helping us achieve this success. Together, we'll continue to drive innovation in the global livestock industry, making livestock management smarter with the latest tech.

For more information, please visit:  
[iLivestock.com/news](https://iLivestock.com/news)

*We know what ranchers need, because we've been making products for them for years*



## Our drive

*Helping ranchers move their business forward*



## The iLivestock platform

---



### All-in-one precision technology

---

As an all-in-one platform for sheep and cattle ranchers, iLivestock combines farm software, reading and weighing tools, and dedicated support—helping ranchers easily manage their livestock, maximise productivity, and improve profitability.



### Support

---

#### Support that works as hard as you do

Whether you're new to iLivestock or a long-time user, our support gives you everything you need to understand, use, and get the most from your ranch technology.

At iLivestock, we go beyond just selling tools—we help ranchers succeed with hands-on training, expert advice, and real support when it matters. From onboarding to live demos and events, we're with you every step of the way.



### Warranty

---

#### Manufacturer warranty

At iLivestock, we stand by the quality of our products, and to ensure your peace of mind, all our hardware units come with manufacturer warranty services, details of which can be found within your hardware subscription agreement. Additionally, we go the extra mile to minimise any disruptions to ranching operations.





Find us in the  
app stores



*Built for cattle and  
sheep ranchers,  
iLivestock puts ranch  
management at your  
fingertips.*

## iLivestock Software





Use it on your smartphone, tablet, or PC/Mac anytime, anywhere. Easily track your animals, save time, and increase your profits. With iLivestock, you'll make smarter year to year decisions backed by real data.

The software works both online and offline, generates instant farm-level reports, and keeps your whole team in sync in real time. With world-class breeding and weight tracking features, plus built-in support, managing your ranch has never been easier.

**Features that will simplify your work on the ranch. Anytime, anywhere.**

- Compliance
- Weighing
- Breeding
- Grouping
- Reporting

## Benefits

-  Multiple users
-  Made in the UK
-  No Internet required
-  PC Dashboard reporting
-  Third-party compatibility
-  One platform for cattle and sheep



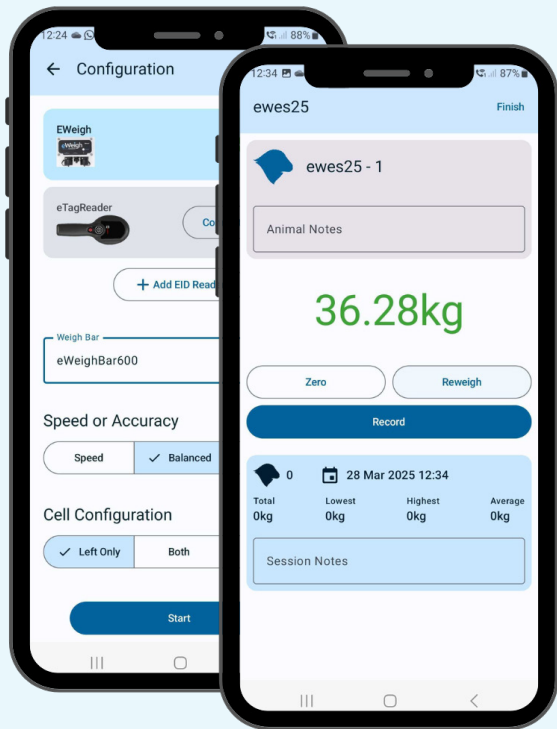

Find us in the  
app stores



*“The only free app that records unique EID numbers with weights”*

## iLivestock eWeigh Software







A free app to connect a farmer’s smartphone (compatible with both Android and iOS) to our innovative eWeigh weigh indicator. There is no other farm software provider that offers this service for free.

With no need for sign-ups and a straightforward user interface, it’s designed to make livestock weighing as effortless as possible. Download now and take control of your livestock management.

## Offline software to weigh, record, and export livestock data

- Add notes to records
- Real-time weight data
- Tracking of average daily gain
- Automatic session saving

## Features

-  Works without Internet
-  Visual or EID capabilities
-  Monitor and analyse weight trends over time
-  No sign-up required
-  Integrates with third-party EID readers
-  Live support chat in the app
-  Export session information for sharing





*“The only compact RFID reader that reads tags up to 38cm”*

## iLivestock’s eTagReader

Maximise the value of your EID tag with the iLivestock **eTagReader**. Whether you’re managing a small family ranch or a large-scale operation, our eTagReader is designed for efficient tag scanning, with an impressive detection range of up to 38 centimetres.

The eTagReader helps you improve animal performance while making tracking and management easier. You can quickly identify animals and connect the EID reader to livestock management software to record the data. It’s simple to use and makes tag reading easier than ever.

## Features

-  Reads any RFID EID tag: sheep or cattle
-  Tag reader with an exceptional range of up to 38cm
-  The only EID reader on the market that can be charged with a simple USB-C cable
-  Economical without compromise: no other RFID reader can deliver our performance at our price

## Technical features

- Bluetooth compatible with Apple and Android devices 2.4-inch colour LCD featuring an intuitive menu system
- Certified dust and water- resistant with an IP65 rating
- One-hand operation with 5- way keypad and read button
- Internal memory stores up to 175,000 records
- Extended battery life, facilitating up to 6 hours of continuous use
- Features session creation for later download and analysis
- Reading range of up to 38cm for HDX tags and 32cm for FDX-B tags

## Product information

Dimensions	28cm (L) x 12cm (W)
Box details	Carry Case with foam inserts, USB cable, USB mains charger
Power supply	USB-C









*“One stop weighing and recording, that grows with your ranch business”*

## iLivestock’s eWeigh

The **eWeigh** is a Bluetooth weigh indicator that - when connected to weigh bars or load cells - calculates weight and transmits this data to your smartphone or tablet, where the animal data is stored and can be analysed.

Compatible with most weigh bars and built for farm durability, the eWeigh is rechargeable, easy to use with a single button, and turns your device into an advanced ranch management tool. The best assistant you’ll ever have to weigh your livestock.

## Features

-  One eWeigh weighs cattle and sheep
-  Assembled in the UK, supported by our local team
-  Connects to any load bar or weigh cell, as long as the plug fits
-  Works with or without an EID Reader
-  No computer upload needed

## Technical features

- No need for an Internet connection - it works anywhere
- More than 24-hour battery life of constant weighing
- Integrated Bluetooth connectivity
- Simple to use - one on/off button
- Chargeable with 12-volt power supply
- Can use Visual or EID
- Integrates with iLivestock Farm Software
- Two-year warranty

## Product information

Dimensions	120mm (W) x 65mm (D) x 130mm (H)
Power supply	Lithium-ion battery
Coating	IP67 (dust and water-resistant)
Operating temperature	-20°C - 40°C
Box details	1x power cable (2 parts, power supply unit and 7 pin connecting cable); eWeigh device (includes mounting plate with velcro straps)

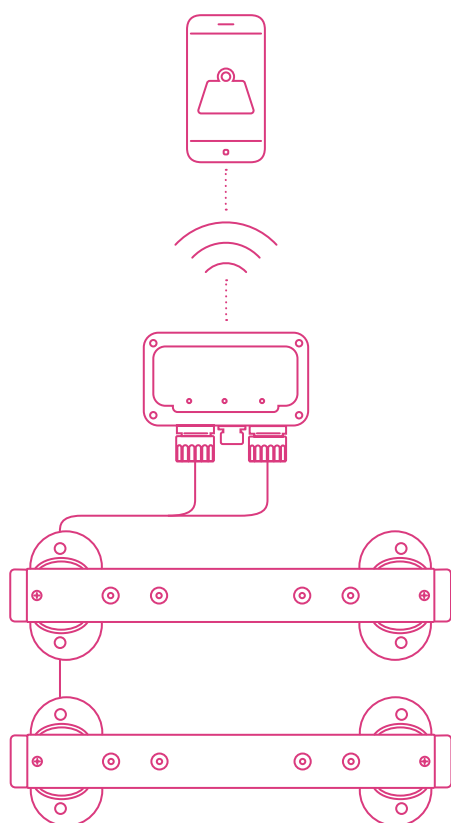



*“Real-time weighing and recording, now visible on the device and ready to power your farm decisions.”*

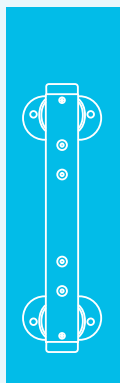







## iLivestock’s eWeighDS

The **eWeighDS** is a Bluetooth weigh indicator with a built-in display that shows the animal’s weight instantly as you work. When connected to weigh bars or load cells, it calculates weight and transmits this data to your smartphone or tablet, where the animal data is stored and can be analysed.

Compatible with most weigh bars and built for farm durability, the **eWeighDS** is rechargeable, easy to use, and gives you the flexibility of both on-device viewing and full app-powered livestock management.

## Features

-  Built-in display shows weight instantly
-  Weighs cattle and sheep
-  Assembled in the UK, supported by our local team
-  Connects to specific load bars
-  Works with or without an app
-  No computer upload needed

## Technical features

- No need for an Internet connection - it works anywhere
- Estimated 27-hour battery life
- Integrated Bluetooth connectivity
- Lightweight design weighing only 1.1kg
- Simple to use - one on/off button
- Can use Visual or EID identification
- Integrates with iLivestock Farm Software
- Two-year warranty

## Product information

Dimensions	120mm (W) x 65mm (D) x 130mm (H)
Power supply	Lithium-ion battery
Coating	IP66
Operating temperature	-20°C - 70°C
Box contains	iLivestock eWeighDS unit 110V - 230V Mains AC adapter Mounting bracket and hardware

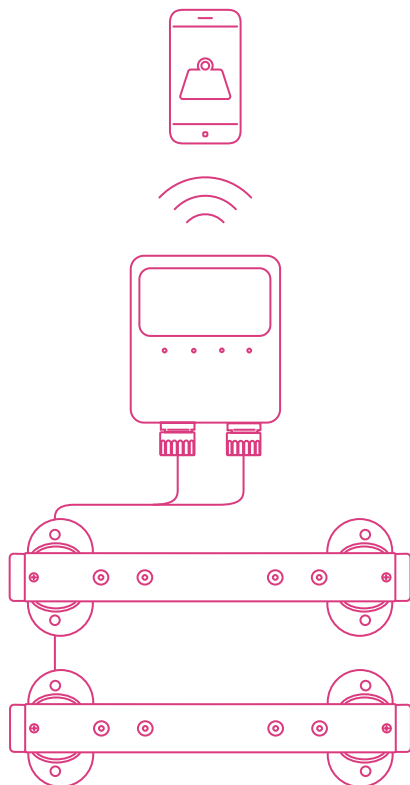



*“Engineered to be tough, reliable, and straightforward to install”*







## eWeighBar600

iLivestock’s **eWeighBar600** load bars are renowned for their robust durability and ability to perform in harsh environments. These bars are engineered to be tough, reliable, and straightforward to install under any livestock weighing crate or platform. The installation process is simple enough that it can be done without any assistance.

With a capacity designed to handle a variety of systems, the eWeighBar600 ensures superior performance and the ideal weighing set-up for your animals.

## Features

-  Heavy capacity up to 2,000kg | 4400lb
-  Compatible with third-party weigh indicators
-  Heavy-duty TPR/PVC cable minimise the risk of cable damage
-  Easy installation onto the crate and secure on level concrete
-  Single-unit design

## Technical features

- Includes 5m PUR/PVC cables with stainless steel spring
- Load cell type: Aircraft grade aluminium double shear beam
- Operations: Aluminium platform, sheep/calf weigh crate
- Warranty: 2 years

## Product information

Coating	Galvanised finish - IP66
Length	600mm / 24"
Capacity	2000kg / 4400lb
Resolution	0.2kg / 0.5lb
Platform fixing points	560mm
Bar width	75mm / 3"
Height	90mm / 3.5"
Weight	16kg
Accuracy	± 1%F.s. or 2d
Operating temperature	-20°C to +40°C
Delivery	Each bar is supplied with eight M10 and four M10 bolts for mounting the platform or crate

## Dimensions

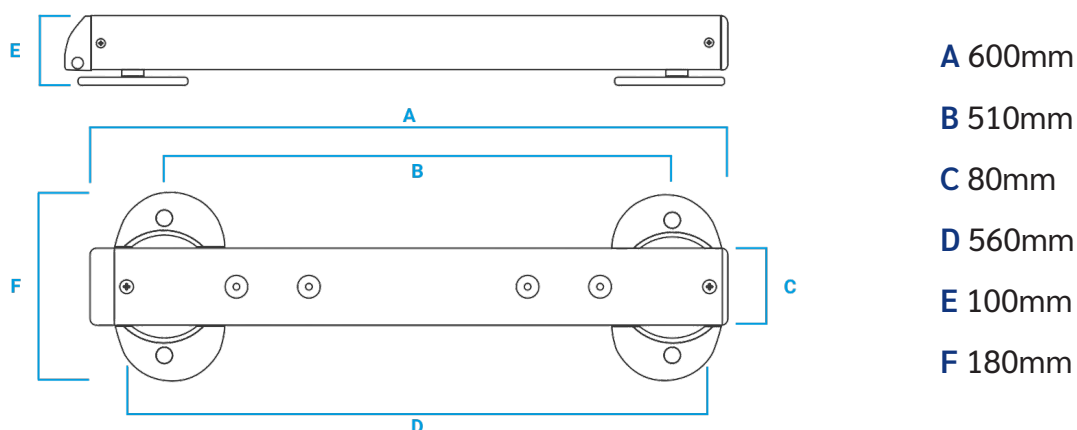



*“Engineered to be tough, reliable, and straightforward to install”*







## eWeighBar800

iLivestock’s **eWeighBar800** load bars are renowned for their robust durability and ability to perform in harsh environments. These bars are engineered to be tough, reliable, and straightforward to install under any livestock weighing crate or platform. The installation process is simple enough that it can be done without any assistance.

With a capacity designed to handle a variety of systems, the eWeighBar800 ensures superior performance and the ideal weighing set-up for your animals.

## Features

-  Heavy capacity up to 3,000kg | 6600lb
-  Compatible with third-party weigh indicators
-  Heavy-duty TPR/PVC cable minimise the risk of cable damage
-  Easy installation onto the crate and secure on level concrete
-  Single-unit design



## Technical features

- Includes 5m PUR/PVC cables with stainless steel spring
- Load cell type: Aircraft grade aluminium double shear beam
- Operating instructions: Sheep/calf weigh crate, sheep/cattle aluminium platform, cattle crush
- Warranty: 2 years

## Product information

Coating	Galvanised finish - IP66
Length	800mm / 32"
Capacity	3000kg / 6600lb
Resolution	0.5kg / 1.0lb
Platform fixing points	760mm
Bar width	75mm / 3"
Height	90mm / 3.5"
Weight	20kg
Accuracy	± 1%F.s. or 2d
Operating temperature	-20°C to +40°C
Delivery	Each bar is supplied with eight M10 and four M10 bolts for mounting the platform or crate

## Dimensions

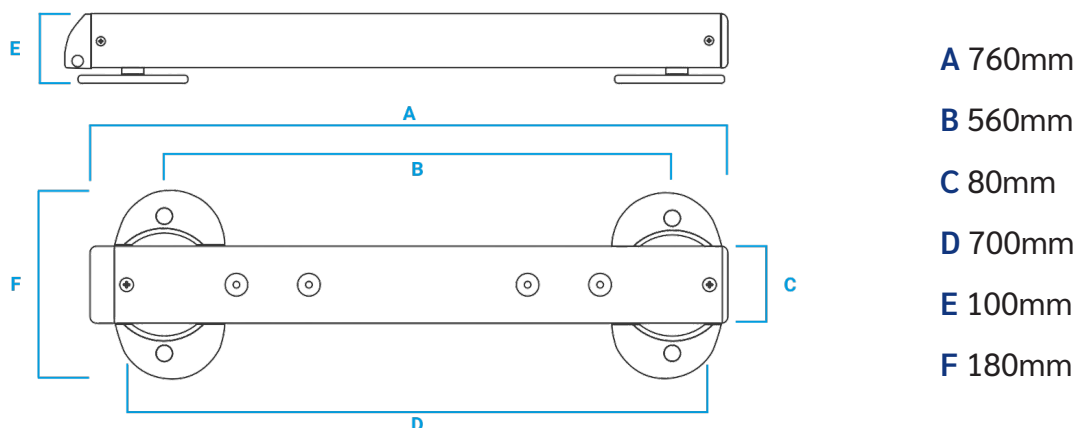



*“Engineered to be tough, reliable, and straightforward to install”*







## eWeighBarHD

iLivestock’s **eWeighBar Heavy Duty** load bars are renowned for their robust durability and ability to perform in harsh environments. These bars are engineered to be tough, reliable, and straightforward to install under any livestock crush. The installation process is simple enough that it can be done without any assistance.

With a capacity designed to handle the heaviest of cattle crushes, the eWeighBarHD ensures superior performance and the ideal weighing set-up for your animals.

## Features

-  Heavy capacity up to 5,000kg | 11000lb
-  Compatible with third-party weigh indicators
-  Heavy-duty TPR/PVC cable minimise the risk of cable damage
-  Easy installation onto the crush and secure on level concrete
-  Single-unit design

## Technical features

- Includes 5m PUR/PVC cables with stainless steel spring
- Load cell type: x2 stainless steel
- Operating instructions: Cattle platform, standard or HD cattle crush
- Warranty: 2 years

## Product information

Coating	Galvanised finish - IP66
Length	1100mm / 43"
Capacity	5000kg / 11000lb
Resolution	0.5kg / 1.0lb
Platform fixing points	Range between 870 - 965mm
Bar width	80mm / 3"
Height	9110mm / 4"
Weight	140kg
Accuracy	± 1%F.s. or 2d
Operating temperature	-20°C to +40°C
Delivery	Each bar is supplied with eight M10 and four M10 bolts for mounting the platform or crate

## Dimensions

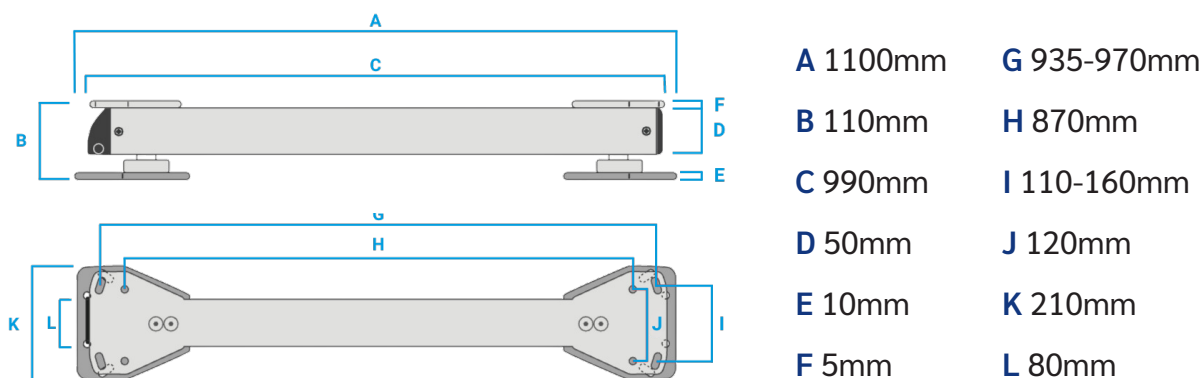



*“Transform your weigh crate or platform into a smart, connected digital weighing system.”*

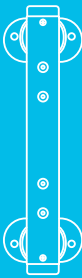







## iLivestock’s eWeighCell

The **eWeighCell** is a durable S-type load cell designed to convert analogue livestock weigh crates into precise digital weighing systems. By suspending your existing crate from the **eWeighCell** and connecting it to your **eWeigh** indicator, you can capture accurate, stable weights directly to your smartphone or tablet.

Built for farm conditions and engineered for accuracy, the **eWeighCell** brings modern performance to traditional equipment. Helping you upgrade, not replace.

## Features

-  Gives precise, stable weights even with moving animals.
-  Durable design built to withstand harsh conditions.
-  Simple to setup. Suspend your crate, connect to eWeigh indicator, and weigh.
-  Send weights directly to smartphone or tablet via the eWeigh.
-  Upgrade your equipment without buying a full new scale.
-  Two year warranty.



## Product information

Capacity	300kg / 660lbs
Rated Output	2.0000 ± 0.004 mV/V
Repeatability	±0.02% F.S
Zero Balance	±1% F.S.
Material	Alloy Steel
Operating Temperature	-30°C to 70°C
Protection Class	IP67 waterproof and dustproof rating
Safe Overload	150% F.S
Ultimate Overload	200% F.S
Cable Length	3 meters
Input resistance	385 ±10 Ω
Output resistance	350 ±5 Ω

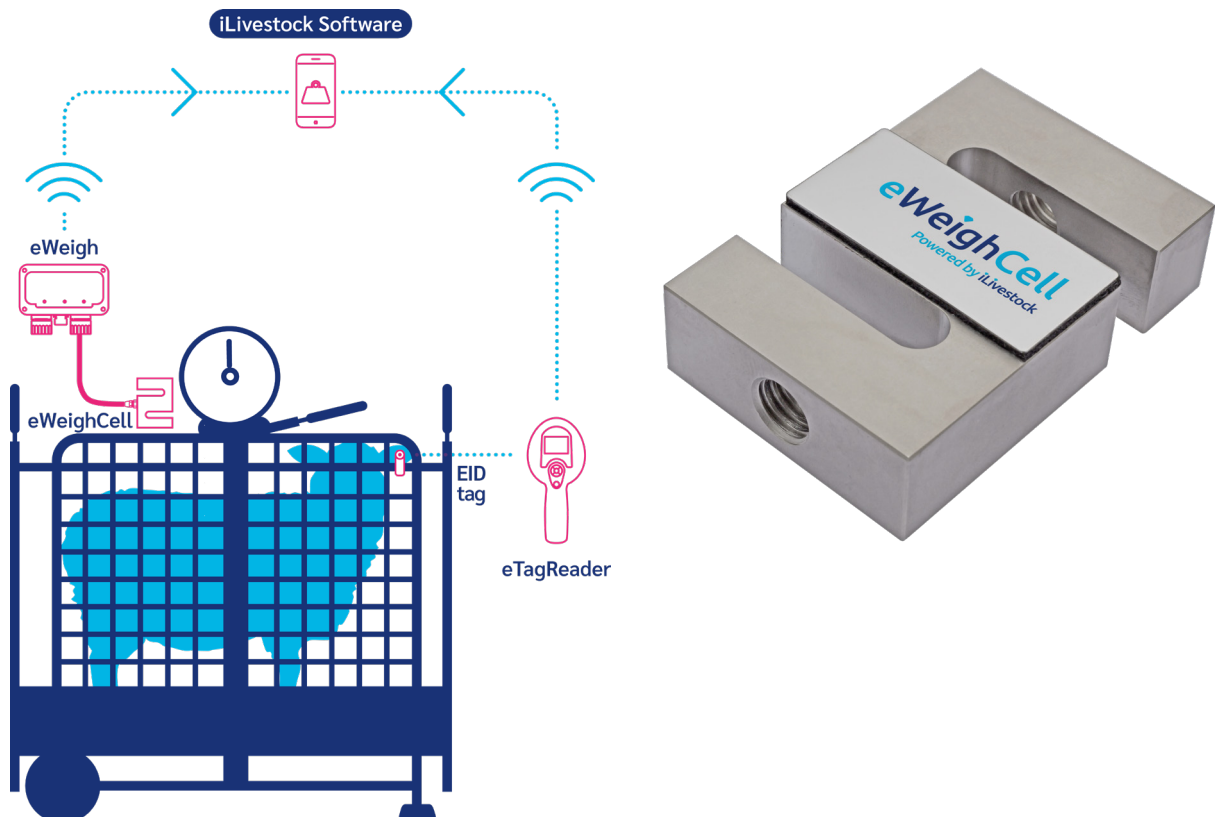
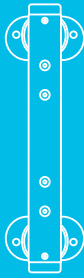



TWIN CLOVER  
  
*Equipment*

315-545-2027

dh@twinclover.net

twincloverequipment.com

CONNECT WITH US:

---



twincloverequipment.com